

PART NO. CA-XXNFH-12GT-XX

REVISIONS			
LTR	DESCRIPTION	DATE	APPROVED
A	INITIAL RELEASE SEE ECR 1974	11-07-91	A.J.
B	SEE ECD 1744	3-27-92	A.J.
C	SEE ECD 2057	11-22-93	A.J.
D	SEE ECD 2307	4-3-95	A.J.
E	SEE DD 3860	DL 2-1-00	A.J.
F	SEE DD 5490	CP 5-21-04	A.J.
G	SEE DD 6379	CP 3-06-07	A.J.
H	SEE DD 6672	CP 6-10-08	A.J.
J	SEE DD 7312	CP 2-06-15	I.M.
K	SEE DD 7336	CP 7-02-15	I.M.
L	SEE DD 7495	CP 12-28-18	T.L.
M	SEE DD 7594	CP 01-22-21	T.L.
N	SEE DD 7604	CP 02-24-21	T.L.

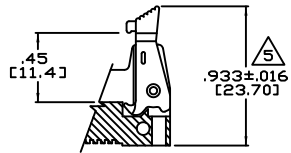

**SHORT LATCH EJECTOR**  
FOR USE WITH CA-NFS WITHOUT STRAIN RELIEF

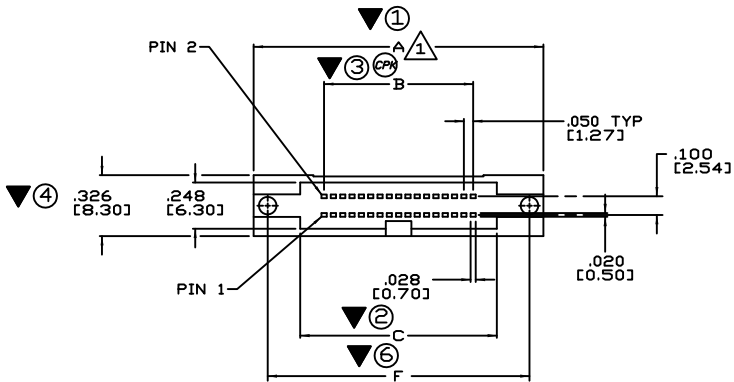
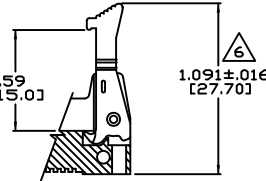

**LONG LATCH EJECTOR**  
FOR USE WITH CA-NFS WITH STRAIN RELIEF

TABULATION:

NO. OF POSITIONS	A		B		C		LONG		D		SHORT		E		F	
	IN	MM	IN	MM	IN	MM	IN	MM	IN	MM	IN	MM	IN	MM	IN	MM
10	.955	24.29	.200	5.08	.456	11.59	1.583	40.20	1.373	34.87	.594	15.08	.806	20.47		
16	1.105	28.09	.350	8.89	.606	15.39	1.733	44.00	1.523	38.68	.744	18.89	.956	24.29		
20	1.205	30.63	.450	11.43	.706	17.93	1.833	46.55	1.623	41.22	.844	21.43	1.056	26.83		
26	1.355	34.44	.600	15.24	.856	21.74	1.983	50.36	1.773	45.03	.994	25.24	1.206	30.64		
34	1.555	39.52	.800	20.32	1.056	26.82	2.183	55.45	1.973	50.11	1.194	30.32	1.406	35.72		
40	1.705	43.33	.950	24.13	1.206	30.63	2.333	59.26	2.123	53.92	1.344	34.13	1.556	39.53		
50	1.955	49.69	1.200	30.48	1.456	36.99	2.583	65.60	2.373	60.27	1.594	40.49	1.806	45.89		
60	2.205	56.03	1.450	36.83	1.706	43.33	2.833	71.96	2.623	66.62	1.844	46.83	2.056	52.23		
64	2.305	58.57	1.550	39.37	1.806	45.87	2.933	74.50	2.723	69.16	1.944	49.37	2.156	54.77		
80	2.705	68.73	1.950	49.53	2.206	56.03	3.333	84.66	3.123	79.32	2.344	59.53	2.556	64.93		
100	3.205	81.43	2.450	62.23	2.706	68.73	3.833	97.36	3.623	92.02	2.844	72.23	3.056	77.63		

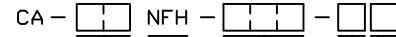

NUMBER OF CONTACT POS: \_\_\_\_\_  
 NANOFLEX SHROUDED HDR: \_\_\_\_\_  
 PLATING:  
 12GT = CONTACT AREA: .000012 [0.00030] GOLD  
 TAIL AREA: .000100 [0.00254] TIN  
 UNDERPLATE: .000150 [0.00381] NICKEL

LATCH OPTION:  
 0 = NO LATCHES  
 1 = WITH SHORT LATCHES  
 2 = WITH LONG LATCHES  
 MOUNTING HARDWARE:  
 0 = NONE

- PARTS SHALL BE: "MOISTURE SENSITIVITY LEVEL # 1".
- MARK 'X' DIMENSION MUST BE CONTROLLED.  
 MARK 'X' IS DIMENSION No.  
 MARK 'CP' DIMENSION MUST BE CONTROLLED BY CPK.
- MEETS THE REQUIREMENTS OF THE EUROPEAN PARLIAMENT AND THE RESTRICTION OF THE USE OF CERTAIN HAZARDOUS SUBSTANCES IN ELECTRICAL AND ELECTRONIC EQUIPMENT. (RoHS)
- INTERPRET DIMENSIONS AND TOLERANCES PER ANSI Y14.5M-1994
- X INDICATES INSPECTION CRITERIA LINE ITEM NO.
- INSULATOR MATERIAL: GLASS FILLED POLYESTER, UL94V-0, COLOR: CUSTOM BLUE (PANTONE 298 C - 299 C).
- CONTACT MATERIAL: PHOSPHOR BRONZE.
- FOR DETAIL SPECIFICATION, REFER TO DRAWING NUMBER CA-100199

NOTES: UNLESS OTHERWISE SPECIFIED.

DIMENSIONS ARE IN INCHES TOLERANCES ARE: DECIMALS ANGLES .XX ± .010 ± 3° .XXX ± .005	APPROVALS DATE DRAWN R.PRITCHETT 11-06-91 CHECKED A.JOCHEN 11-07-91	<b>CA</b> CIRCUIT ASSEMBLY CORP. 6 ATRY SUITE#150, IRVINE, CALIFORNIA 92618 CONNECTOR ASSEMBLY-NFH SERIES CA-XXNFH-XXX-XX, NANOFLEX, SHROUDED HDR, RoHS
DIMENSIONS IN BRACKETS [XXX] ARE IN MILLIMETERS TOLERANCES ARE: DECIMALS ANGLES .X ± .25 ± 3° .XX ± .13	THE INFORMATION AND DESIGN DISCLOSED HEREIN WAS ORIGINATED BY AND IS THE PROPERTY OF CIRCUIT ASSEMBLY CORPORATION. RESERVES ALL PATENT, PROPRIETARY DESIGN, AND SALES RIGHTS THEREIN, AND TO ANY ARTICLE, DESIGN, OR OTHER EXCEPT TO THE EXTENT RIGHTS ARE EXPRESSLY GRANTED TO OTHERS. THE FOREGOING DOES NOT APPLY TO VENDOR PROPRIETARY RIGHTS.	SIZE CODE IDENT NO. DRAWING NO. REV. C 52072 620341 N
DO NOT SCALE DRAWING	SCALE: 2 : 1	SHEET 1 OF 1

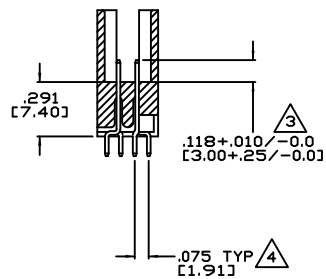
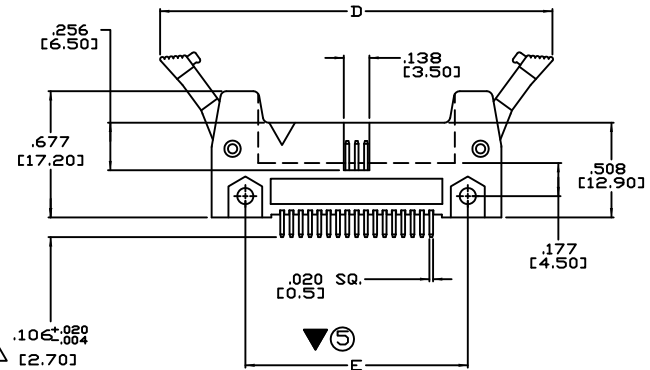

P.C.B. HOLE PATTERN (COMPONENT SIDE)

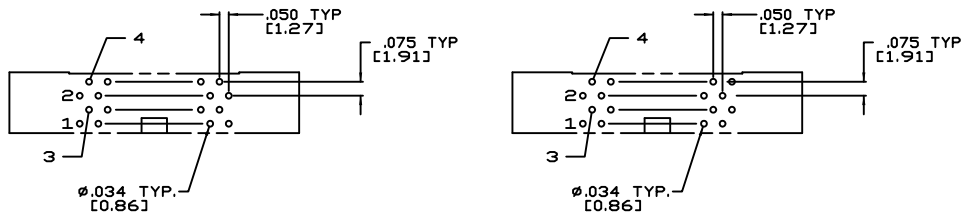

FOR THE FOLLOWING SIZES:  
10,26,34 AND 50

FOR THE FOLLOWING SIZES:  
16,20,40,60,64,80 AND 100